

Data sheet for SIMOTICS S-1FK2

Article No. : 1FK2104-5AK11-1MB0

Client order no. :
Order no. :
Offer no. :
Remarks :

Item no. :
Consignment no. :
Project :

Figure similar

Basic motor data	
Motor type	Permanent-magnet synchronous motor, Natural cooling, IP65
Motor type	High Dynamic
Static torque	2.40 Nm
Static current	4.4 A
Maximum torque	7.60 Nm
Maximum current	16.0 A
Maximum speed	8,000 rpm
Rotor moment of inertia	0.6500 kgcm ²
Weight	3.7 kg

Rated data	
SINAMICS S120, BLM/SLM 3AC 400V	
Rated speed	6,000 rpm
Rated torque	1.70 Nm
Rated current	3.2 A
Rated power	1.07 kW

Encoder system	
Encoder system	Encoder AM22DQC: Absolute encoder 22 bit + 12 bit multiturn

Motor connection	
Connection type	Double cable connection for S120
Connector size power connector	M17
Connector size signal connector	M17

Mechanical data	
Design acc. to Code I	IM B5 (IM V1, IM V3)
Vibration severity grade	Grade A
Shaft height	40
Flange size (AB)	80 mm
Centering ring (N)	70 mm
Hole circle (M)	90 mm
Screw-on hole (S)	6.5 mm
Overall length (LB)	170 mm
Diameter of shaft (D)	19 mm
Length of shaft (E)	40 mm
Length of flange diagonal (P)	105 mm
Shaft end	Fitted key
Color of the housing	Standard (Anthracite, similar to RAL 7016)

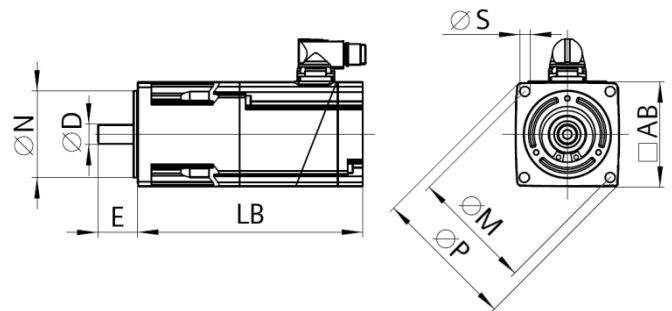

Holding brake	
Holding torque	3.30 Nm
Average dynamic torque	3.30 Nm
Opening time	110 ms
Closing time	40 ms
Maximum single switching energy ¹⁾	270 J
Service life, operating energy	35,000 J
Rated current ²⁾	0.5 A

¹⁾Up to three consecutive emergency stops and up to 25% of all emergency stops as a Wmax high energy stop possible.

²⁾Typical value for 20°C ambient temperature. At -15°C the break-induced currents can be increased by up to 30%.

TURLL

YOUR GLOBAL AUTOMATION PARTNER

1FK2104-5AK11-1MB0-S1FK2-HD

OFFICIAL DATASHEET & QUOTATION

- 100% New & Original Factory Sealed
- Global Express Shipping (DHL/FedEx/UPS)
- 12-Month Warranty Protection
- Professional Technical Support

[CHECK STOCK & PRICE](#)



Need Assistance? Scan to Chat on WhatsApp

sales@turl.com | +852 6339 7344