











Cable connector size S00 screw terminal

product brand name	SIRIUS
product category	Plugs, adapters and terminals
product designation	Connection plug
design of the product	Size S00
product type designation	3RV29
General technical data	
certificate of suitability	CE / UL / CSA / CCC
size of the circuit-breaker	S00
power loss [W] for rated value of the current at AC in hot operating state per pole	0.4 W
type of calculation of power loss depending on pole	quadratic
protection class IP on the front according to IEC 60529	IP20
thermal current	16 A
Substance Prohibition (Date)	10/01/2009
Net Weight	0.044 kg
number of poles for main current circuit	3
operating voltage at AC rated value	500 V
operational current rated value	16 A
ampacity maximum	16 A
UL/CSA ratings	
operating voltage at AC according to UL rated value	600 V
Ambient conditions	
ambient temperature	
• during operation	-20 ... +60 °C
• during storage	-50 ... +80 °C
Environmental footprint	
Environmental Product Declaration (EPD)	Yes
global warming potential [CO2 eq] total	9.06 kg
global warming potential [CO2 eq] during manufacturing	0.313 kg
global warming potential [CO2 eq] during operation	8.72 kg
global warming potential [CO2 eq] after end of life	0.022 kg
Electrical Safety	
protection class IP on the front according to IEC 60529	IP20
touch protection on the front according to IEC 60529	finger-safe, for vertical contact from the front
Installation/ mounting/ dimensions	
height	42 mm
width	45 mm
depth	54 mm
Approvals Certificates	

General Product Approval		Test Certificates	Maritime application		
		Special Test Certificate			
Maritime application			other		
			Miscellaneous		Confirmation
other	Railway	Environment			
	Special Test Certificate		Environmental Confirmations		

Further information

Information on the packaging

<https://support.industry.siemens.com/cs/ww/en/view/109813875>

Information for data generation and storage

<https://support.industry.siemens.com/cs/ww/en/view/109995012>

Information- and Downloadcenter (Catalogs, Brochures,...)

<https://www.siemens.com/ic10>

Industry Mall (Online ordering system)

<https://mall.industry.siemens.com/mall/en/en/Catalog/product?mlfb=3RV2917-5CA00>

Cax online generator

<https://support.automation.siemens.com/WW/CAXorder/default.aspx?lang=en&mlfb=3RV2917-5CA00>

Service&Support (Manuals, Certificates, Characteristics, FAQs,...)

<https://support.industry.siemens.com/cs/ww/en/ps/3RV2917-5CA00>

Image database (product images, 2D dimension drawings, 3D models, device circuit diagrams, EPLAN macros, ...)

https://www.automation.siemens.com/bilddb/cax_de.aspx?mlfb=3RV2917-5CA00&lang=en

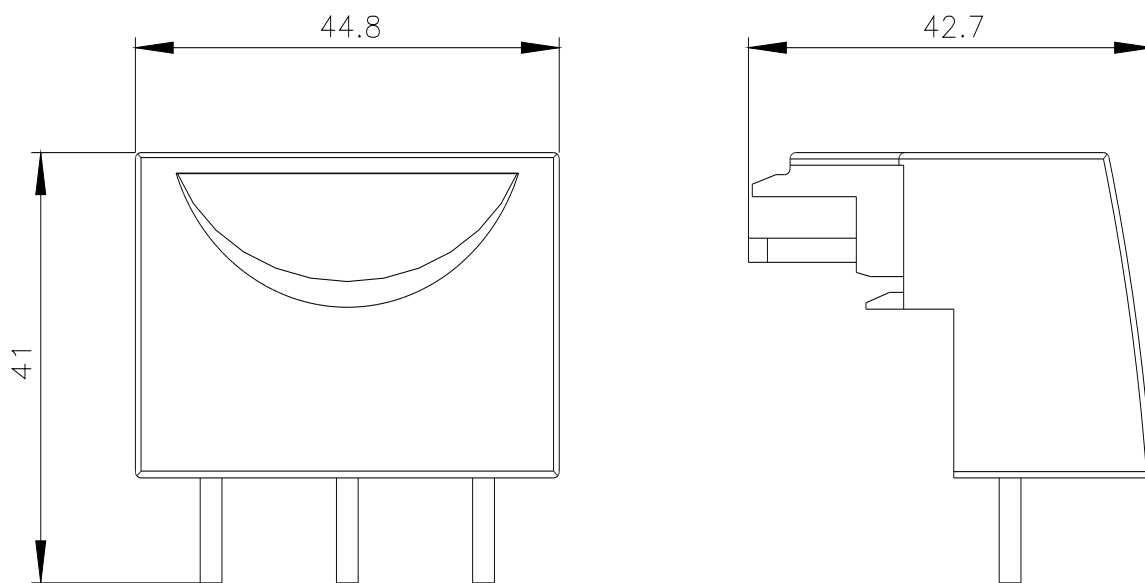

last modified:

4/2/2025 

TURLL

YOUR GLOBAL AUTOMATION PARTNER

3RV2917-5CA00

OFFICIAL DATASHEET & QUOTATION

- 100% New & Original Factory Sealed
- Global Express Shipping (DHL/FedEx/UPS)
- 12-Month Warranty Protection
- Professional Technical Support

[CHECK STOCK & PRICE](#)



Need Assistance? Scan to Chat on WhatsApp

sales@turl.com | +852 6339 7344