









Siemens  
EcoTech



EMERGENCY STOP mushroom pushbutton, 22 mm, round, metal, shiny, red, 40 mm, positive latching, acc. to EN ISO 13850, pull-to-unlatch mechanism



product brand name	SIRIUS ACT
product designation	EMERGENCY STOP mushroom pushbuttons
design of the product	Actuating/signaling element
product type designation	3SU1
product line	Metal, shiny, 22 mm
<b>Enclosure</b>	
number of command points	1
<b>Actuator</b>	
design of the actuating element	positive latching
principle of operation of the actuating element	latching
product extension optional	
• light source	No
• contact module	Yes
color	
• of the actuating element	red
material of the actuating element	plastic
shape of the actuating element	round
outer diameter of the actuating element	40 mm
type of unlocking device	pull-to-unlatch mechanism
number of switching positions	2
<b>Front ring</b>	
product component front ring	No
<b>General technical data</b>	
product function	
• positive opening	Yes
• EMERGENCY OFF function	Yes
• EMERGENCY STOP function	Yes
protection class IP	IP66, IP67, IP69(IP69K)
degree of protection NEMA rating	1, 2, 3, 3R, 4, 4X, 12, 13
shock resistance	
• according to IEC 60068-2-27	sinusoidal half-wave 15g / 11 ms
vibration resistance	
• according to IEC 60068-2-6	10 ... 500 Hz: 5g
operating frequency maximum	600 1/h
mechanical service life (operating cycles) typical	300 000
reference code according to IEC 81346-2	S

<b>Substance Prohibitance (Date)</b>	10/01/2014
<b>Net Weight</b>	96 g
<b>Safety related data</b>	
product function suitable for safety function	Yes
<b>service life maximum</b>	20 a
<b>test wear-related service life necessary</b>	Yes
<b>proportion of dangerous failures</b>	
• with low demand rate according to SN 31920	20 %
• with high demand rate per NC contact according to SN 31920	20 %
• with high demand rate per NO contact according to SN 31920	50 %
<b>B10 value with high demand rate according to SN 31920</b>	100 000
<b>failure rate [FIT] with low demand rate per NC contact according to SN 31920</b>	100 FIT
<b>ISO 13849</b>	
<b>device type according to ISO 13849-1</b>	3
<b>IEC 61508</b>	
<b>safety device type according to IEC 61508-2</b>	Type A
T1 value for proof test interval or service life according to IEC 61508	20 a
<b>Ambient conditions</b>	
<b>ambient temperature</b>	
• during operation	-25 ... +70 °C
• during storage	-40 ... +80 °C
environmental category during operation according to IEC 60721	3M6, 3S2, 3B2, 3C3, 3K6 (with relative air humidity of 10 ... 95%)
<b>Environmental footprint</b>	
Environmental Product Declaration (EPD)	Yes
global warming potential [CO2 eq] total	0.593 kg
global warming potential [CO2 eq] during manufacturing	0.625 kg
global warming potential [CO2 eq] during operation	0.235 kg
global warming potential [CO2 eq] after end of life	-0.267 kg
Siemens Eco Profile (SEP)	Siemens EcoTech
<b>Installation/ mounting/ dimensions</b>	
<b>shape of the installation opening</b>	round
<b>mounting diameter</b>	22.3 mm
<b>positive tolerance of installation diameter</b>	0.4 mm
<b>mounting height</b>	45.3 mm
<b>installation width</b>	40 mm
<b>installation depth</b>	26.3 mm
<b>Approvals Certificates</b>	
<b>General Product Approval</b>	<b>Test Certificates</b>
    	<a href="#">Type Test Certificates/Test Report</a>
<b>Test Certificates</b>	<b>Maritime application</b>
<a href="#">Special Test Certificate</a>	   
<b>other</b>	<b>Confirmation</b>
<b>other</b>	<b>Environment</b>



[Environmental Con-  
firmations](#)

#### Further information

**Information on the packaging**

<https://support.industry.siemens.com/cs/ww/en/view/109813875>

**Information for data generation and storage**

<https://support.industry.siemens.com/cs/ww/en/view/109995012>

**Information- and Downloadcenter (Catalogs, Brochures,...)**

<https://www.siemens.com/ic10>

**Industry Mall (Online ordering system)**

<https://mall.industry.siemens.com/mall/en/en/Catalog/product?mlfb=3SU1050-1HA20-0AA0>

**Cax online generator**

<https://support.automation.siemens.com/WW/CAXorder/default.aspx?lang=en&mlfb=3SU1050-1HA20-0AA0>

**Service&Support (Manuals, Certificates, Characteristics, FAQs,...)**

<https://support.industry.siemens.com/cs/ww/en/ps/3SU1050-1HA20-0AA0>

**Image database (product images, 2D dimension drawings, 3D models, device circuit diagrams, EPLAN macros, ...)**

[https://www.automation.siemens.com/bilddb/cax\\_de.aspx?mlfb=3SU1050-1HA20-0AA0&lang=en](https://www.automation.siemens.com/bilddb/cax_de.aspx?mlfb=3SU1050-1HA20-0AA0&lang=en)

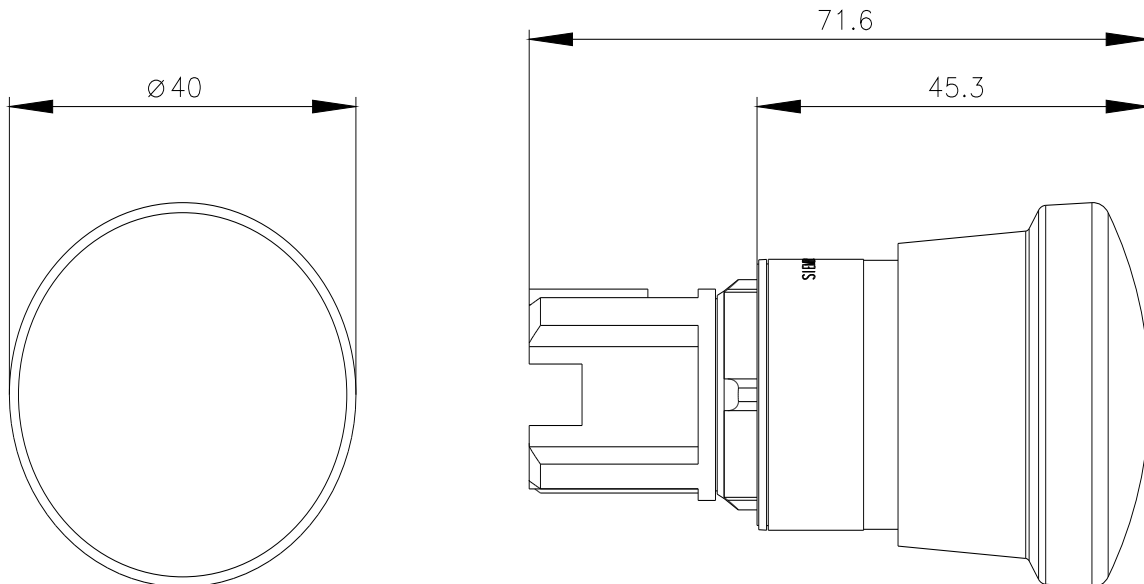

last modified:

9/30/2025

# TURLL

YOUR GLOBAL AUTOMATION PARTNER

## 3SU1050-1HA20-0AA0

OFFICIAL DATASHEET & QUOTATION

- 100% New & Original Factory Sealed
- Global Express Shipping (DHL/FedEx/UPS)
- 12-Month Warranty Protection
- Professional Technical Support

[CHECK STOCK & PRICE](#)



Need Assistance? Scan to Chat on WhatsApp

[sales@turl.com](mailto:sales@turl.com) | +852 6339 7344