











Siemens
EcoTech



EMERGENCY STOP mushroom pushbutton, 22 mm, round, metal, shiny, red, 40 mm, positive latching, acc. to EN ISO 13850, rotate-to-unlatch



product brand name	SIRIUS ACT
product designation	EMERGENCY STOP mushroom pushbuttons
design of the product	Actuating/signaling element
product type designation	3SU1
product line	Metal, shiny, 22 mm
Enclosure	
number of command points	1
Actuator	
design of the actuating element	positive latching
principle of operation of the actuating element	latching
product extension optional	
• light source	No
• contact module	Yes
color	
• of the actuating element	red
material of the actuating element	plastic
shape of the actuating element	round
outer diameter of the actuating element	40 mm
type of unlocking device	rotate-to-unlatch mechanism
number of switching positions	2
Front ring	
product component front ring	No
General technical data	
product function	
• positive opening	Yes
• EMERGENCY OFF function	Yes
• EMERGENCY STOP function	Yes
protection class IP	IP66, IP67, IP69(IP69K)
degree of protection NEMA rating	1, 2, 3, 3R, 4, 4X, 12, 13
shock resistance	
• according to IEC 60068-2-27	sinusoidal half-wave 15g / 11 ms
vibration resistance	
• according to IEC 60068-2-6	10 ... 500 Hz: 5g
operating frequency maximum	600 1/h
mechanical service life (operating cycles) typical	300 000
reference code according to IEC 81346-2	S

Substance Prohibitance (Date)	10/01/2014
Net Weight	92 g
Safety related data	
product function suitable for safety function	Yes
service life maximum	20 a
test wear-related service life necessary	Yes
proportion of dangerous failures	
• with low demand rate according to SN 31920	20 %
• with high demand rate per NC contact according to SN 31920	20 %
• with high demand rate per NO contact according to SN 31920	50 %
B10 value with high demand rate according to SN 31920	100 000
failure rate [FIT] with low demand rate per NC contact according to SN 31920	100 FIT
ISO 13849	
device type according to ISO 13849-1	3
IEC 61508	
safety device type according to IEC 61508-2	Type A
T1 value for proof test interval or service life according to IEC 61508	20 a
Ambient conditions	
ambient temperature	
• during operation	-25 ... +70 °C
• during storage	-40 ... +80 °C
environmental category during operation according to IEC 60721	3M6, 3S2, 3B2, 3C3, 3K6 (with relative air humidity of 10 ... 95%)
Environmental footprint	
Environmental Product Declaration (EPD)	Yes
global warming potential [CO2 eq] total	0.593 kg
global warming potential [CO2 eq] during manufacturing	0.625 kg
global warming potential [CO2 eq] during operation	0.235 kg
global warming potential [CO2 eq] after end of life	-0.267 kg
Siemens Eco Profile (SEP)	Siemens EcoTech
Installation/ mounting/ dimensions	
shape of the installation opening	round
mounting diameter	22.3 mm
positive tolerance of installation diameter	0.4 mm
mounting height	45.3 mm
installation width	40 mm
installation depth	26.3 mm
Approvals Certificates	
General Product Approval	Test Certificates
    	Type Test Certificates/Test Report
Test Certificates	Maritime application
Special Test Certificate	    
other	Environment

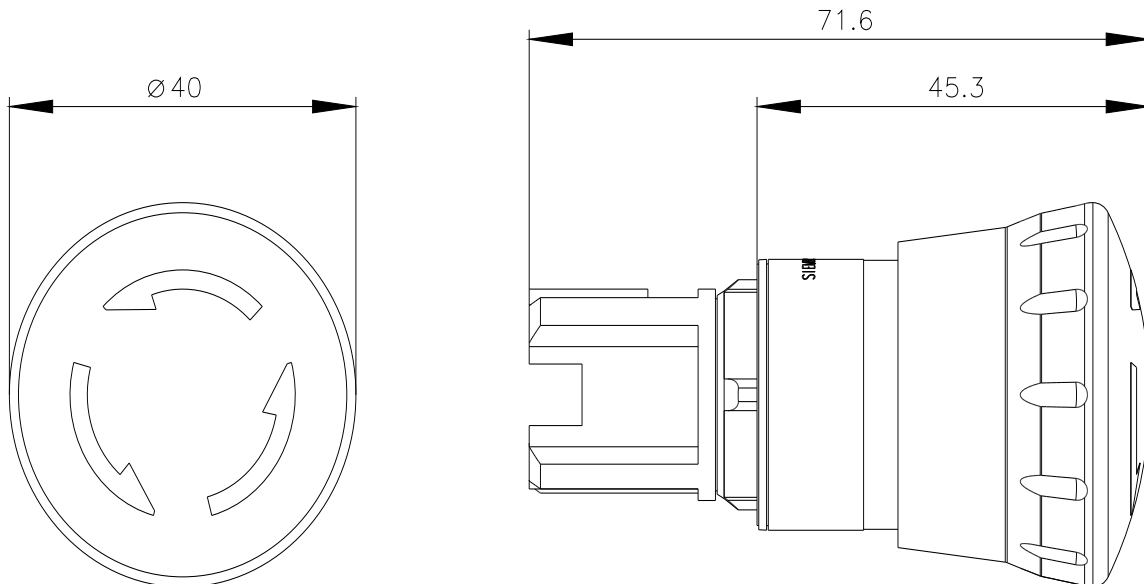
[Confirmation](#)Siemens
EcoTech[Environmental Con-
firmations](#)**Further information****Information on the packaging**<https://support.industry.siemens.com/cs/ww/en/view/109813875>**Information for data generation and storage**<https://support.industry.siemens.com/cs/ww/en/view/109995012>**Information- and Downloadcenter (Catalogs, Brochures,...)**<https://www.siemens.com/ic10>**Industry Mall (Online ordering system)**<https://mall.industry.siemens.com/mall/en/en/Catalog/product?mlfb=3SU1050-1HB20-0AA0>**Cax online generator**<https://support.automation.siemens.com/WW/CAXorder/default.aspx?lang=en&mlfb=3SU1050-1HB20-0AA0>**Service&Support (Manuals, Certificates, Characteristics, FAQs,...)**<https://support.industry.siemens.com/cs/ww/en/ps/3SU1050-1HB20-0AA0>**Image database (product images, 2D dimension drawings, 3D models, device circuit diagrams, EPLAN macros, ...)**https://www.automation.siemens.com/bilddb/cax_de.aspx?mlfb=3SU1050-1HB20-0AA0&lang=en

last modified:

9/30/2025

TURLL

YOUR GLOBAL AUTOMATION PARTNER

3SU1050-1HB20-0AA0

OFFICIAL DATASHEET & QUOTATION

- 100% New & Original Factory Sealed
- Global Express Shipping (DHL/FedEx/UPS)
- 12-Month Warranty Protection
- Professional Technical Support

[CHECK STOCK & PRICE](#)



Need Assistance? Scan to Chat on WhatsApp

sales@turl.com | +852 6339 7344