











Siemens  
EcoTech



EMERGENCY STOP mushroom pushbutton, 22 mm, round, metal, shiny, red, 40 mm, with RONIS lock, lock number SB30, positive latching, acc. to EN ISO 13850, key-operated release



product brand name	SIRIUS ACT
product designation	EMERGENCY STOP mushroom pushbuttons
design of the product	Actuating/signaling element
product type designation	3SU1
product line	Metal, shiny, 22 mm
<b>Enclosure</b>	
number of command points	1
<b>Actuator</b>	
design of the actuating element	positive latching
principle of operation of the actuating element	latching
product extension optional	
• light source	No
• contact module	Yes
color	
• of the actuating element	red
material of the actuating element	plastic
shape of the actuating element	round
outer diameter of the actuating element	40 mm
type of unlocking device	Unlocking
number of switching positions	2
switch position for key distraction	O
lock make	RONIS
key number	SB30
<b>Front ring</b>	
product component front ring	No
<b>General technical data</b>	
product function	
• positive opening	Yes
• EMERGENCY OFF function	Yes
• EMERGENCY STOP function	Yes
protection class IP	IP66, IP67, IP69(IP69K)
degree of protection NEMA rating	1, 2, 3, 3R, 4, 4X, 12, 13
shock resistance	
• according to IEC 60068-2-27	sinusoidal half-wave 15g / 11 ms
vibration resistance	
• according to IEC 60068-2-6	10 ... 500 Hz: 5g

operating frequency maximum	600 1/h	
mechanical service life (operating cycles) typical	300 000	
reference code according to IEC 81346-2	S	
Substance Prohibittance (Date)	10/01/2014	
Net Weight	115 g	
<b>Safety related data</b>		
product function suitable for safety function	Yes	
service life maximum	20 a	
test wear-related service life necessary	Yes	
proportion of dangerous failures		
• with low demand rate according to SN 31920	20 %	
• with high demand rate per NC contact according to SN 31920	20 %	
• with high demand rate per NO contact according to SN 31920	50 %	
<b>B10 value with high demand rate according to SN 31920</b>	100 000	
<b>failure rate [FIT] with low demand rate per NC contact according to SN 31920</b>	100 FIT	
<b>ISO 13849</b>		
device type according to ISO 13849-1	3	
<b>IEC 61508</b>		
safety device type according to IEC 61508-2	Type A	
T1 value for proof test interval or service life according to IEC 61508	20 a	
<b>Ambient conditions</b>		
ambient temperature		
• during operation	-25 ... +70 °C	
• during storage	-40 ... +80 °C	
environmental category during operation according to IEC 60721	3M6, 3S2, 3B2, 3C3, 3K6 (with relative air humidity of 10 ... 95%)	
<b>Environmental footprint</b>		
Environmental Product Declaration (EPD)	Yes	
global warming potential [CO2 eq] total	0.593 kg	
global warming potential [CO2 eq] during manufacturing	0.625 kg	
global warming potential [CO2 eq] during operation	0.235 kg	
global warming potential [CO2 eq] after end of life	-0.267 kg	
Siemens Eco Profile (SEP)	Siemens EcoTech	
<b>Installation/ mounting/ dimensions</b>		
shape of the installation opening	round	
mounting diameter	22.3 mm	
positive tolerance of installation diameter	0.4 mm	
mounting height	67.1 mm	
installation width	40 mm	
installation depth	26.3 mm	
<b>Approvals Certificates</b>		
General Product Approval	Test Certificates	
    	<a href="#">Type Test Certificates/Test Report</a>	
Test Certificates	Maritime application	other
<a href="#">Special Test Certificate</a>	   	
other	Environment	

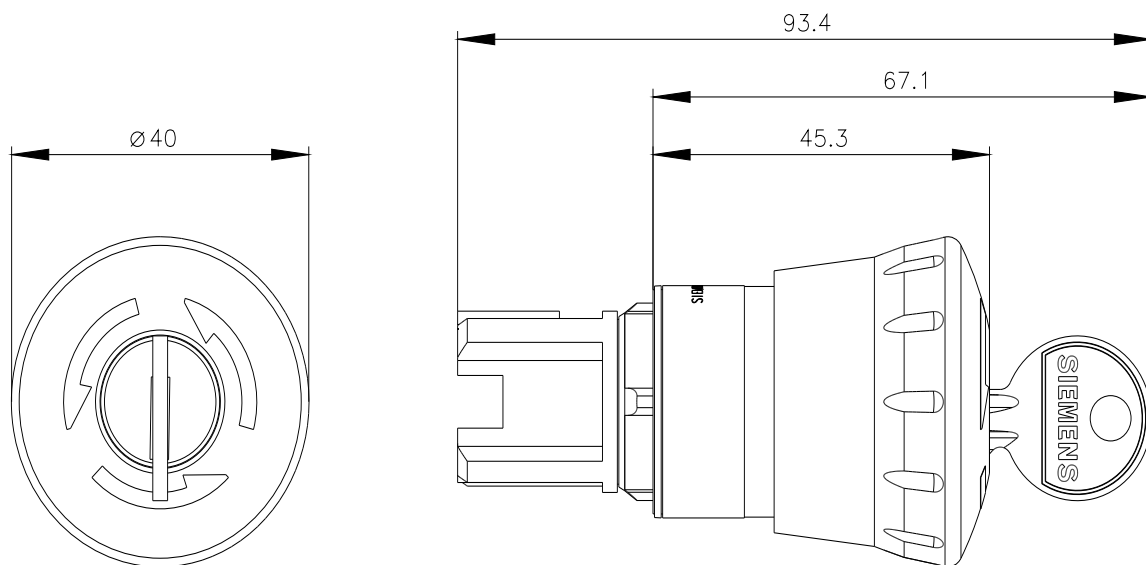
[Confirmation](#)Siemens  
EcoTech[Environmental Con-  
firmations](#)**Further information****Information on the packaging**<https://support.industry.siemens.com/cs/ww/en/view/109813875>**Information for data generation and storage**<https://support.industry.siemens.com/cs/ww/en/view/109995012>**Information- and Downloadcenter (Catalogs, Brochures,...)**<https://www.siemens.com/ic10>**Industry Mall (Online ordering system)**<https://mall.industry.siemens.com/mall/en/en/Catalog/product?mlfb=3SU1050-1HF20-0AA0>**Cax online generator**<https://support.automation.siemens.com/WW/CAXorder/default.aspx?lang=en&mlfb=3SU1050-1HF20-0AA0>**Service&Support (Manuals, Certificates, Characteristics, FAQs,...)**<https://support.industry.siemens.com/cs/ww/en/ps/3SU1050-1HF20-0AA0>**Image database (product images, 2D dimension drawings, 3D models, device circuit diagrams, EPLAN macros, ...)**[https://www.automation.siemens.com/bilddb/cax\\_de.aspx?mlfb=3SU1050-1HF20-0AA0&lang=en](https://www.automation.siemens.com/bilddb/cax_de.aspx?mlfb=3SU1050-1HF20-0AA0&lang=en)

last modified:

9/30/2025

# TURLL

YOUR GLOBAL AUTOMATION PARTNER

## 3SU1050-1HF20-0AA0

OFFICIAL DATASHEET & QUOTATION

- 100% New & Original Factory Sealed
- Global Express Shipping (DHL/FedEx/UPS)
- 12-Month Warranty Protection
- Professional Technical Support

[CHECK STOCK & PRICE](#)



Need Assistance? Scan to Chat on WhatsApp

sales@turl.com | +852 6339 7344