



Indicator lights, 22 mm, round, metal, shiny, blue, lens, smooth







product brand name	SIRIUS ACT
product designation	Indicator lights
design of the product	Actuating/signaling element
product type designation	3SU1
product line	Metal, shiny, 22 mm
Actuator	
product extension optional	
• light source	Yes
• contact module	No
color	
• of the actuating element	blue
• of the cover cap	blue
material of the actuating element	plastic
shape of the actuating element	round
outer diameter of the actuating element	29.45 mm
Front ring	
product component front ring	No
material of the front ring	plastic
color of the front ring	black
General technical data	
protection class IP	IP66, IP67, IP69(IP69K)
degree of protection NEMA rating	1, 2, 3, 3R, 4, 4X, 12, 13
shock resistance	
• according to IEC 60068-2-27	sinusoidal half-wave 15g / 11 ms
vibration resistance	
• according to IEC 60068-2-6	10 ... 500 Hz: 5g
reference code according to IEC 81346-2	P
Substance Prohibitance (Date)	10/01/2014
Net Weight	25 g
Connections/ Terminals	
tightening torque of the screws in the bracket	1 ... 1.2 N·m
Ambient conditions	
ambient temperature	
• during operation	-25 ... +70 °C
• during storage	-40 ... +80 °C
environmental category during operation according to IEC	3M6, 3S2, 3B2, 3C3, 3K6 (with relative air humidity of 10 ... 95%)

60721	
Environmental footprint	
Environmental Product Declaration(EPD)	Yes
global warming potential [CO2 eq] total	0.593 kg
global warming potential [CO2 eq] during manufacturing	0.625 kg
global warming potential [CO2 eq] during operation	0.235 kg
global warming potential [CO2 eq] after end of life	-0.267 kg
Siemens Eco Profile (SEP)	Siemens EcoTech
Installation/ mounting/ dimensions	
height	29.5 mm
width	29.5 mm
shape of the installation opening	round
mounting diameter	22.3 mm
positive tolerance of installation diameter	0.4 mm
mounting height	11.8 mm
installation width	29.5 mm
installation depth	24.4 mm

Approvals Certificates

General Product Approval	Test Certificates	Maritime application
   	Type Test Certificates/Test Report	

Maritime application	other	Environment
  		

Environment

 	Environmental Confirmations
---	---

Further information

Information on the packaging https://support.industry.siemens.com/cs/ww/en/view/109813875
Information for data generation and storage https://support.industry.siemens.com/cs/ww/en/view/109995012
Information- and Downloadcenter (Catalogs, Brochures,...) https://www.siemens.com/ic10
Industry Mall (Online ordering system) https://mall.industry.siemens.com/mall/en/en/Catalog/product?mlfb=3SU1051-6AA50-0AA0
Cax online generator https://support.automation.siemens.com/WW/CAXorder/default.aspx?lang=en&mlfb=3SU1051-6AA50-0AA0
Service&Support (Manuals, Certificates, Characteristics, FAQs,...) https://support.industry.siemens.com/cs/ww/en/ps/3SU1051-6AA50-0AA0
Image database (product images, 2D dimension drawings, 3D models, device circuit diagrams, EPLAN macros, ...) https://www.automation.siemens.com/bilddb/cax_de.aspx?mlfb=3SU1051-6AA50-0AA0&lang=en

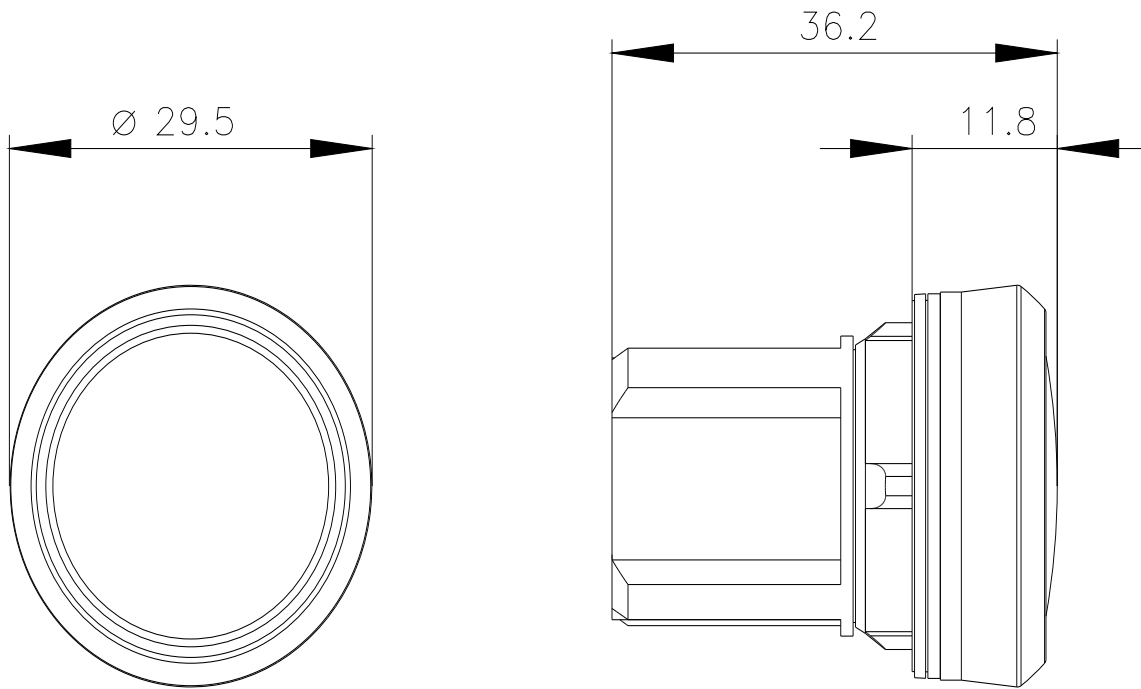

last modified:

11/15/2025 

TURLL

YOUR GLOBAL AUTOMATION PARTNER

3SU1051-6AA50-0AA0

OFFICIAL DATASHEET & QUOTATION

- 100% New & Original Factory Sealed
- Global Express Shipping (DHL/FedEx/UPS)
- 12-Month Warranty Protection
- Professional Technical Support

[CHECK STOCK & PRICE](#)



Need Assistance? Scan to Chat on WhatsApp

sales@turl.com | +852 6339 7344