











Siemens  
EcoTech



Illuminable selector switch, 22 mm, round, metal shiny, yellow, Selector switch short, 2 switch positions O-I, latching, actuating angle 90°, 10:30h/13:30h



product brand name	SIRIUS ACT
product designation	Selector switches
design of the product	Actuating/signaling element
product type designation	3SU1
product line	Metal, shiny, 22 mm
<b>Enclosure</b>	
number of command points	1
<b>Actuator</b>	
design of the actuating element	Selector, short
principle of operation of the actuating element	latching, 90° (10:30 h/13:30 h)
product extension optional	
• light source	Yes
• contact module	Yes
color of the actuating element	yellow
material of the actuating element	plastic
shape of the actuating element	Handle
outer diameter of the actuating element	32.3 mm
number of switching positions	2
actuating angle	
• clockwise	90°
<b>Front ring</b>	
product component front ring	Yes
design of the front ring	standard
material of the front ring	Metal, high gloss
color of the front ring	silver
<b>General technical data</b>	
protection class IP	IP66, IP67, IP69(IP69K)
degree of protection NEMA rating	1, 2, 3, 3R, 4, 4X, 12, 13
shock resistance	
• according to IEC 60068-2-27	sinusoidal half-wave 15g / 11 ms
vibration resistance	
• according to IEC 60068-2-6	10 ... 500 Hz: 5g
operating frequency maximum	1 800 1/h
mechanical service life (operating cycles) typical	1 000 000
reference code according to IEC 81346-2	S
Substance Prohibition (Date)	10/01/2014

<b>Net Weight</b>	48 g
<b>Safety related data</b>	
<b>proportion of dangerous failures</b>	
<ul style="list-style-type: none"> <li>with low demand rate according to SN 31920</li> </ul>	20 %
<ul style="list-style-type: none"> <li>with high demand rate per NC contact according to SN 31920</li> </ul>	20 %
<ul style="list-style-type: none"> <li>with high demand rate per NO contact according to SN 31920</li> </ul>	50 %
<b>B10 value with high demand rate according to SN 31920</b>	100 000
<b>failure rate [FIT] with low demand rate per NC contact according to SN 31920</b>	100 FIT
<b>IEC 61508</b>	
T1 value for proof test interval or service life according to IEC 61508	20 a
<b>Ambient conditions</b>	
<b>ambient temperature</b>	
<ul style="list-style-type: none"> <li>during operation</li> </ul>	-25 ... +70 °C
<ul style="list-style-type: none"> <li>during storage</li> </ul>	-40 ... +80 °C
environmental category during operation according to IEC 60721	3M6, 3S2, 3B2, 3C3, 3K6 (with relative air humidity of 10 ... 95%)
<b>Environmental footprint</b>	
Environmental Product Declaration (EPD)	Yes
global warming potential [CO2 eq] total	0.593 kg
global warming potential [CO2 eq] during manufacturing	0.625 kg
global warming potential [CO2 eq] during operation	0.235 kg
global warming potential [CO2 eq] after end of life	-0.267 kg
Siemens Eco Profile (SEP)	Siemens EcoTech
<b>Installation/ mounting/ dimensions</b>	
<b>height</b>	32.3 mm
<b>width</b>	32.3 mm
<b>shape of the installation opening</b>	round
<b>mounting diameter</b>	22.3 mm
<b>positive tolerance of installation diameter</b>	0.4 mm
<b>mounting height</b>	28.8 mm
<b>installation width</b>	32.3 mm
<b>installation depth</b>	25.4 mm
<b>Approvals Certificates</b>	
<b>General Product Approval</b>	<b>Test Certificates</b>
   	<a href="#">Type Test Certificates/Test Report</a> <a href="#">Special Test Certificate</a>
<b>Maritime application</b>	<b>other</b>
   	 <a href="#">Confirmation</a>
<b>Environment</b>	
 	<a href="#">Environmental Confirmations</a>
<b>Further information</b>	
<b>Information on the packaging</b> <a href="https://support.industry.siemens.com/cs/ww/en/view/109813875">https://support.industry.siemens.com/cs/ww/en/view/109813875</a>	

## Information for data generation and storage

<https://support.industry.siemens.com/cs/ww/en/view/109995012>

## Information- and Downloadcenter (Catalogs, Brochures,...)

<https://www.siemens.com/ic10>

## Industry Mall (Online ordering system)

<https://mall.industry.siemens.com/mall/en/en/Catalog/product?mlfb=3SU1052-2BF30-0AA0>

## Cax online generator

<https://support.automation.siemens.com/WW/CAXorder/default.aspx?lang=en&mlfb=3SU1052-2BF30-0AA0>

## Service&amp;Support (Manuals, Certificates, Characteristics, FAQs,...)

<https://support.industry.siemens.com/cs/ww/en/ps/3SU1052-2BF30-0AA0>

## Image database (product images, 2D dimension drawings, 3D models, device circuit diagrams, EPLAN macros, ...)

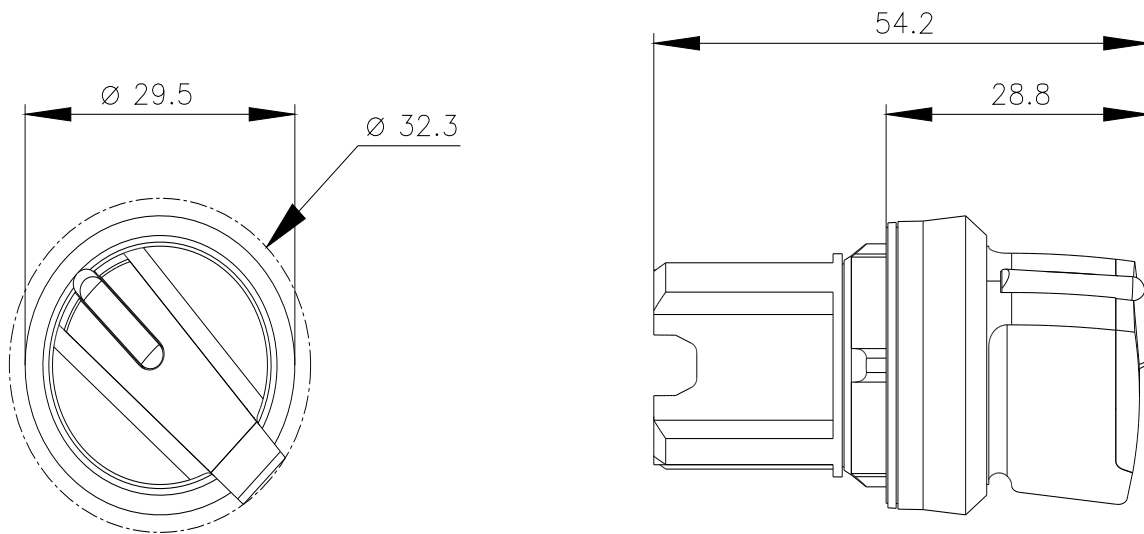
[https://www.automation.siemens.com/bilddb/cax\\_de.aspx?mlfb=3SU1052-2BF30-0AA0&lang=en](https://www.automation.siemens.com/bilddb/cax_de.aspx?mlfb=3SU1052-2BF30-0AA0&lang=en)

last modified:

5/21/2025

# TURLL

YOUR GLOBAL AUTOMATION PARTNER

## 3SU1052-2BF30-0AA0

OFFICIAL DATASHEET & QUOTATION

- 100% New & Original Factory Sealed
- Global Express Shipping (DHL/FedEx/UPS)
- 12-Month Warranty Protection
- Professional Technical Support

[CHECK STOCK & PRICE](#)



Need Assistance? Scan to Chat on WhatsApp

[sales@turl.com](mailto:sales@turl.com) | +852 6339 7344