

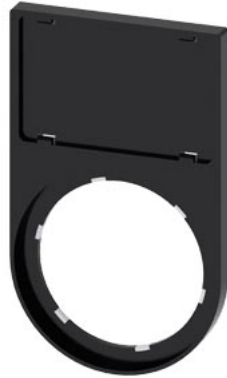





## Data sheet

## 3SU1900-0AS10-0AA0



Label holder, 22mm, flat, Frame rounded off at the bottom black, for labeling plate 17.5 mm x 27 mm, for snapping on

product brand name	SIRIUS ACT	
product designation	Label holder	
design of the product	for labeling plate 17.5 x 27 mm	
product type designation	3SU1	
<b>General technical data</b>		
protection class IP	IP66, IP67, IP69(IP69K)	
degree of protection NEMA rating	1, 2, 3, 3R, 4, 4X, 12	
shock resistance for railway applications according to EN 61373	Category 1, Class B	
vibration resistance for railway applications according to EN 61373	Category 1, Class B	
Substance Prohibance (Date)	10/01/2014	
Net Weight	2 g	
<b>Ambient conditions</b>		
ambient temperature		
• during operation	70 ... -25 °C	
• during storage and transport	80 ... -40 °C	
<b>Environmental footprint</b>		
Environmental Product Declaration(EPD)	Yes	
global warming potential [CO2 eq] total	0.787 kg	
global warming potential [CO2 eq] during manufacturing	0.566 kg	
global warming potential [CO2 eq] during operation	0.235 kg	
global warming potential [CO2 eq] after end of life	-0.015 kg	
<b>Installation/ mounting/ dimensions</b>		
height	49.8 mm	
width	29.8 mm	
<b>Accessories</b>		
material of accessory	Plastic	
shape of label holder	rounded below	
color of label holder	Black	
fastening method of label	snap on	
<b>Approvals Certificates</b>		
General Product Approval	Test Certificates	Maritime application
 EG-Konf.		
	<a href="#">Type Test Certificates/Test Report</a>	
Maritime application	other	Environment

[Confirmation](#)

## Environment

Siemens  
EcoTech



[Environmental Confirmations](#)

## Further information

Information on the packaging

<https://support.industry.siemens.com/cs/ww/en/view/109813875>

Information for data generation and storage

<https://support.industry.siemens.com/cs/ww/en/view/109995012>

Information- and Downloadcenter (Catalogs, Brochures,...)

<https://www.siemens.com/ic10>

Industry Mall (Online ordering system)

<https://mall.industry.siemens.com/mall/en/en/Catalog/product?mlfb=3SU1900-0AS10-0AA0>

Cax online generator

<https://support.automation.siemens.com/WW/CAXorder/default.aspx?lang=en&mlfb=3SU1900-0AS10-0AA0>

Service&Support (Manuals, Certificates, Characteristics, FAQs,...)

<https://support.industry.siemens.com/cs/ww/en/ps/3SU1900-0AS10-0AA0>

Image database (product images, 2D dimension drawings, 3D models, device circuit diagrams, EPLAN macros, ...)

[https://www.automation.siemens.com/bilddb/cax\\_de.aspx?mlfb=3SU1900-0AS10-0AA0&lang=en](https://www.automation.siemens.com/bilddb/cax_de.aspx?mlfb=3SU1900-0AS10-0AA0&lang=en)

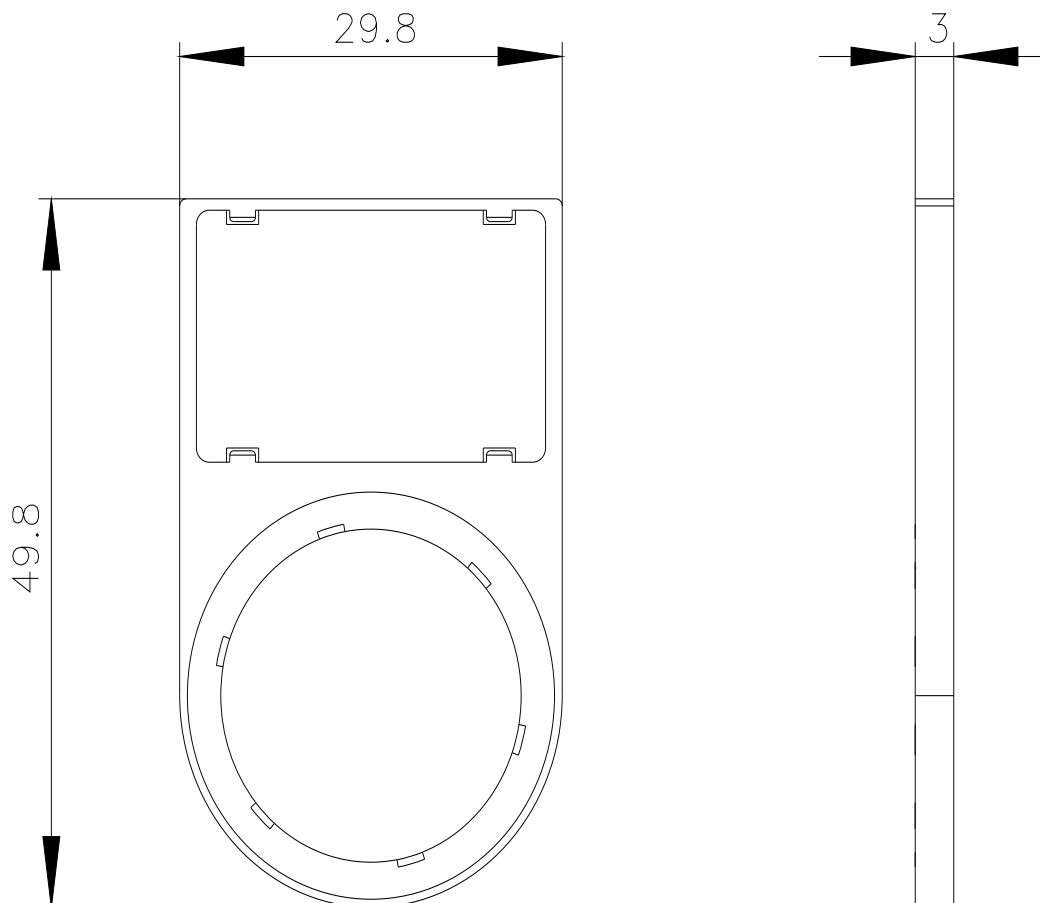

last modified:

4/2/2025

# TURLL

YOUR GLOBAL AUTOMATION PARTNER

## 3SU1900-0AS10-0AA0

OFFICIAL DATASHEET & QUOTATION

- 100% New & Original Factory Sealed
- Global Express Shipping (DHL/FedEx/UPS)
- 12-Month Warranty Protection
- Professional Technical Support

[CHECK STOCK & PRICE](#)



Need Assistance? Scan to Chat on WhatsApp

sales@turl.com | +852 6339 7344