

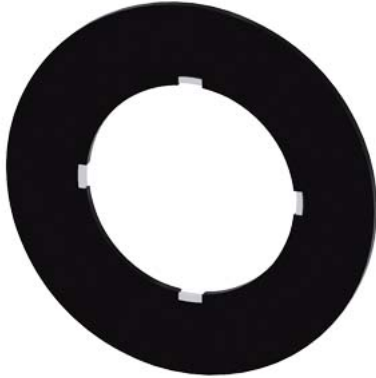





Data sheet

3SU1900-0BG16-0AA0



Labeling plate for potentiometer, black label, without inscription, Outer diameter 40 mm

product brand name	SIRIUS ACT	
product designation	Labeling plate	
design of the product	for potentiometers	
product type designation	3SU1	
General technical data		
protection class IP	IP66, IP67, IP69(IP69K)	
shock resistance for railway applications according to EN 61373	Category 1, Class B	
vibration resistance for railway applications according to EN 61373	Category 1, Class B	
Substance Prohibitation (Date)	10/01/2014	
Net Weight	1 g	
Ambient conditions		
ambient temperature		
• during operation	70 ... -25 °C	
• during storage and transport	80 ... -40 °C	
Environmental footprint		
Environmental Product Declaration(EPD)	Yes	
global warming potential [CO2 eq] total	0.787 kg	
global warming potential [CO2 eq] during manufacturing	0.566 kg	
global warming potential [CO2 eq] during operation	0.235 kg	
global warming potential [CO2 eq] after end of life	-0.015 kg	
Accessories		
material of accessory	Plastic	
fastening method of label	without	
marking of the name plate for command devices	ohne	
shape of the name plate for command devices	round	
color of the label	black (plate); white (text)	
Approvals Certificates		
General Product Approval	Test Certificates	Maritime application
   	Type Test Certificates/Test Report	
Maritime application	other	Environment



Confirmation



Environment

Siemens
EcoTech
[Environmental Con-
firmations](#)

Further information

Information on the packaging

<https://support.industry.siemens.com/cs/ww/en/view/109813875>

Information for data generation and storage

<https://support.industry.siemens.com/cs/ww/en/view/109995012>

Information- and Downloadcenter (Catalogs, Brochures,...)

<https://www.siemens.com/ic10>

Industry Mall (Online ordering system)

<https://mall.industry.siemens.com/mall/en/en/Catalog/product?mlfb=3SU1900-0BG16-0AA0>

Cax online generator

<https://support.automation.siemens.com/WW/CAXorder/default.aspx?lang=en&mlfb=3SU1900-0BG16-0AA0>

Service&Support (Manuals, Certificates, Characteristics, FAQs,...)

<https://support.industry.siemens.com/cs/ww/en/ps/3SU1900-0BG16-0AA0>

Image database (product images, 2D dimension drawings, 3D models, device circuit diagrams, EPLAN macros, ...)

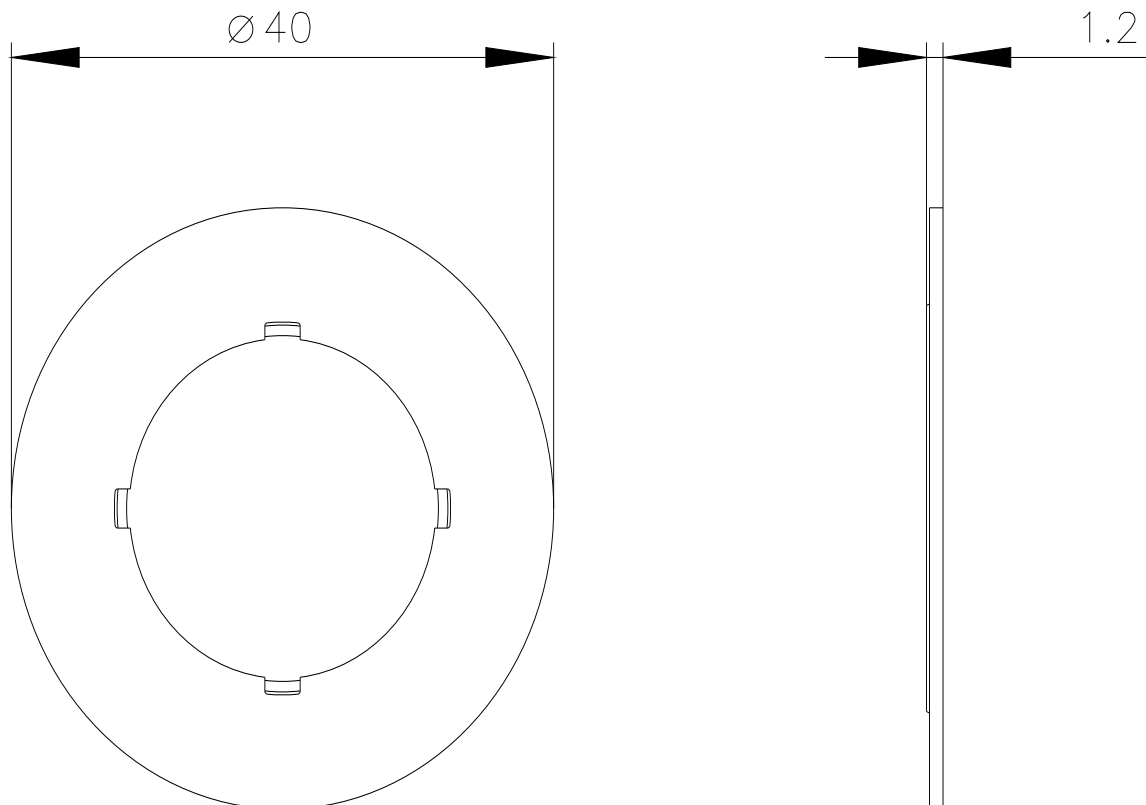
https://www.automation.siemens.com/bilddb/cax_de.aspx?mlfb=3SU1900-0BG16-0AA0&lang=en

last modified:

4/2/2025

TURLL

YOUR GLOBAL AUTOMATION PARTNER

3SU1900-0BG16-0AA0

OFFICIAL DATASHEET & QUOTATION

- 100% New & Original Factory Sealed
- Global Express Shipping (DHL/FedEx/UPS)
- 12-Month Warranty Protection
- Professional Technical Support

[CHECK STOCK & PRICE](#)



Need Assistance? Scan to Chat on WhatsApp

sales@turl.com | +852 6339 7344