









SIEMENS

Data sheet

3SU1900-0EF70-0AA0



Silicone-free protective cover for selector switch short, 22 mm, clear

product brand name	SIRIUS ACT		
product designation	Silicone-free protective cap		
design of the product	for selectors, short		
product type designation	3SU1		
General technical data			
protection class IP	IP66, IP67		
degree of protection NEMA rating	1, 2, 3, 3R, 4, 4X, 12		
Substance Prohibittance (Date)	10/01/2014		
Net Weight	2 g		
Ambient conditions			
ambient temperature			
• during operation	-25 ... +70 °C		
• during storage	-40 ... +80 °C		
Environmental footprint			
Environmental Product Declaration(EPD)	Yes		
global warming potential [CO2 eq] total	0.787 kg		
global warming potential [CO2 eq] during manufacturing	0.566 kg		
global warming potential [CO2 eq] during operation	0.235 kg		
global warming potential [CO2 eq] after end of life	-0.015 kg		
Installation/ mounting/ dimensions			
depth	30 mm		
Accessories			
material of accessory	Plastic		
color of accessory	clear		
Approvals Certificates			
General Product Approval		Test Certificates	Maritime application
			
<small>EG-Konf.</small>			Type Test Certificates/Test Report
			
Maritime application		other	Environment
			
<small>LRS</small>	<small>PRS</small>	<small>RINA</small>	Confirmation
			

Environment

[Environmental Con-
firmations](#)

Further information

Information on the packaging

<https://support.industry.siemens.com/cs/ww/en/view/109813875>

Information for data generation and storage

<https://support.industry.siemens.com/cs/ww/en/view/109995012>

Information- and Downloadcenter (Catalogs, Brochures,...)

<https://www.siemens.com/ic10>

Industry Mall (Online ordering system)

<https://mall.industry.siemens.com/mall/en/en/Catalog/product?mlfb=3SU1900-0EF70-0AA0>

Cax online generator

<https://support.automation.siemens.com/WW/CAXorder/default.aspx?lang=en&mlfb=3SU1900-0EF70-0AA0>

Service&Support (Manuals, Certificates, Characteristics, FAQs,...)

<https://support.industry.siemens.com/cs/ww/en/ps/3SU1900-0EF70-0AA0>

Image database (product images, 2D dimension drawings, 3D models, device circuit diagrams, EPLAN macros, ...)

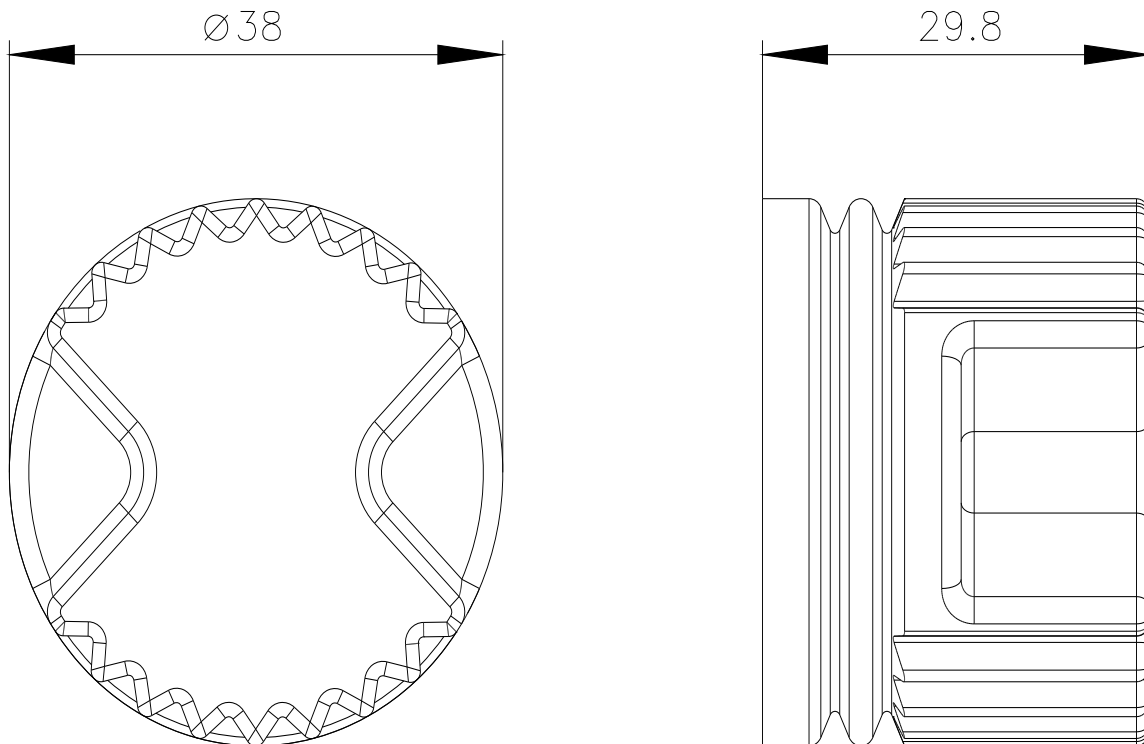
https://www.automation.siemens.com/bilddb/cax_de.aspx?mlfb=3SU1900-0EF70-0AA0&lang=en

last modified:

4/2/2025

TURLL

YOUR GLOBAL AUTOMATION PARTNER

3SU1900-0EF70-0AA0

OFFICIAL DATASHEET & QUOTATION

- 100% New & Original Factory Sealed
- Global Express Shipping (DHL/FedEx/UPS)
- 12-Month Warranty Protection
- Professional Technical Support

[CHECK STOCK & PRICE](#)



Need Assistance? Scan to Chat on WhatsApp

sales@turl.com | +852 6339 7344