

Data sheet









3SU1960-0KB10-0AA0



Adapter for installation of actuators and signaling units, 22 mm, in a mounting drill hole 30.5 mm, Metal, matte, with seal

product brand name	SIRIUS ACT
product designation	Adapter
design of the product	for 30.5 mm to 22.5 mm mounting hole
product type designation	3SU1
General technical data	
protection class IP	IP66, IP67, IP69(IP69K)
Substance Prohibitions (Date)	10/01/2014
Net Weight	32 g
Ambient conditions	
ambient temperature	
• during operation	-25 ... +70 °C
• during storage and transport	-40 ... +80 °C
Installation/ mounting/ dimensions	
height	40 mm
width	38 mm
mounting height	4.6 mm
Accessories	
material of accessory	Metal matt
color of accessory	sand gray

Approvals Certificates

General Product Approval	Test Certificates	Maritime application
 EG-Konf.		
	Type Test Certificates/Test Report	 BUREAU VERITAS
		 LRS
Maritime application	other	Environment
 PRS	 RINA	 产品合格 QC PASS
	Confirmation	Environmental Confirmations

Further information

Information on the packaging

<https://support.industry.siemens.com/cs/ww/en/view/109813875>

Information for data generation and storage

<https://support.industry.siemens.com/cs/ww/en/view/109995012>

Information- and Downloadcenter (Catalogs, Brochures,...)

<https://www.siemens.com/ic10>

Industry Mall (Online ordering system)

<https://mall.industry.siemens.com/mall/en/en/Catalog/product?mlfb=3SU1960-0KB10-0AA0>

Cax online generator

<https://support.automation.siemens.com/WW/CAXorder/default.aspx?lang=en&mlfb=3SU1960-0KB10-0AA0>

Service&Support (Manuals, Certificates, Characteristics, FAQs,...)

<https://support.industry.siemens.com/cs/ww/en/ps/3SU1960-0KB10-0AA0>

Image database (product images, 2D dimension drawings, 3D models, device circuit diagrams, EPLAN macros, ...)

https://www.automation.siemens.com/bilddb/cax_de.aspx?mlfb=3SU1960-0KB10-0AA0&lang=en

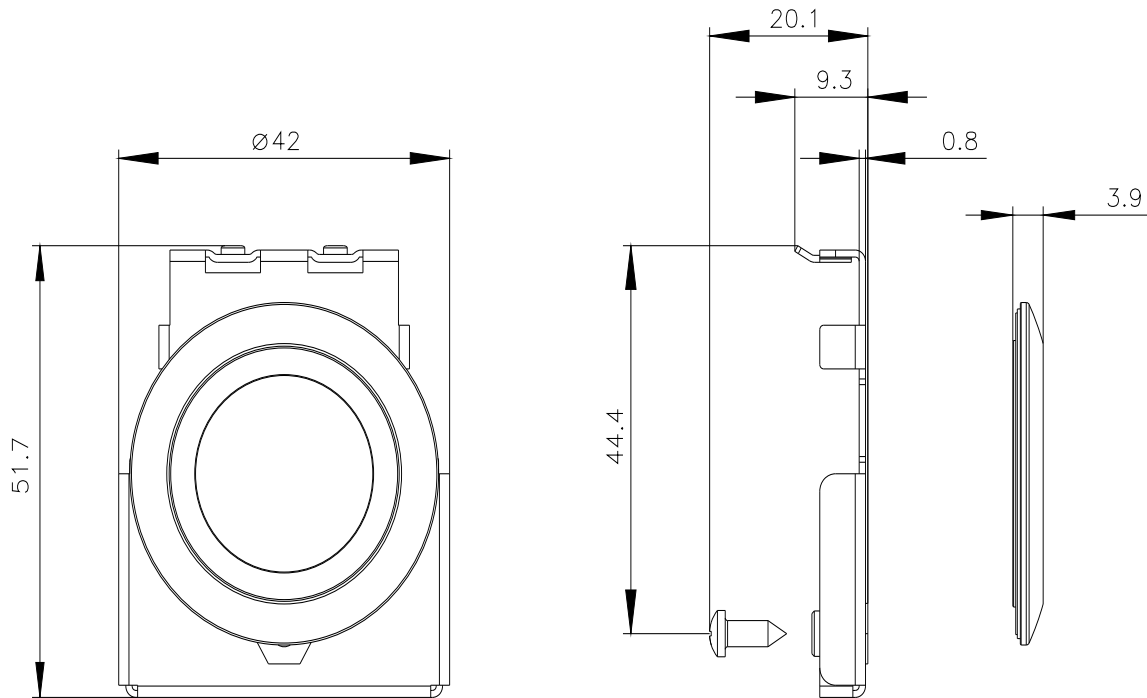

last modified:

4/2/2025

TURLL

YOUR GLOBAL AUTOMATION PARTNER

3SU1960-0KB10-0AA0

OFFICIAL DATASHEET & QUOTATION

- 100% New & Original Factory Sealed
- Global Express Shipping (DHL/FedEx/UPS)
- 12-Month Warranty Protection
- Professional Technical Support

[CHECK STOCK & PRICE](#)



Need Assistance? Scan to Chat on WhatsApp

sales@turl.com | +852 6339 7344